

IC A/MASAI/50/3000K/GOLD/BLACK

Masai Ceiling / Wall Light

by Marco Pagnoncelli

The peculiarity of MASAI is its curved shield on which the light is projected from an oval source. This collection of indirect wall, ceiling and pendant lamps consists of slimline die-cast aluminum profiles with inbuilt LEDs. The simple geometry and essential shape of MASAI creates a clean and sophisticated aesthetic, while its soft indirect lighting produces a comfortable atmosphere. The Masai sconce is surface mounted and suitable for ceiling or wall installation. Available in two sizes in a variety of finish options. Made in Italy.



Designer	Marco Pagnoncelli
Supplier	Icone
Country	Italy
SKU	IC A/MASAI/50/3000K/GOLD/BLACK
Finish	Gold + Black
Size	50
Version	3000K

Product Dimensions

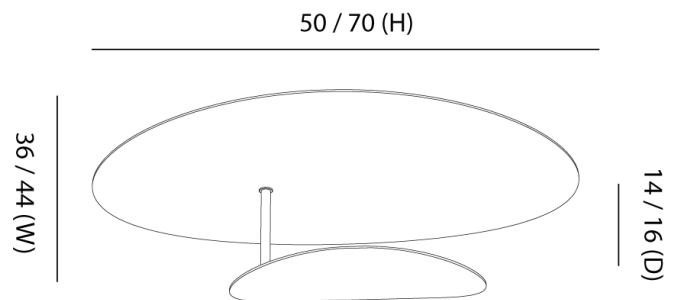

Materials	Aluminium	Source	15W LED	Colour Temp	3000K
Output	1350lm	CRI	>90	Emission	Indirect
Dimming	TRIAC	Notes	Overall Dimensions: 50cm x 36cm x 14cm		