

NE S/ELLISSE/DBL/3000K/WH

Ellisse Pendant Double

by Federico Palazzari

The Ellisse Pendant Double from NEMO is an LED pendant lamp for widespread direct and indirect lighting. Two pendants with opaline diffusers and aluminium bodies hang from a central base to create an overlay effect. Ellisse is manufactured through a proprietary technology to combine the extruded bars. Available in a variety of finishes in 2700K or 3000K.



Designer	Federico Palazzari
Supplier	Nemo
Country	Italy
SKU	NE S/ELLISSE/DBL/3000K/WH
Finish	White
Version	3000K

Product Dimensions

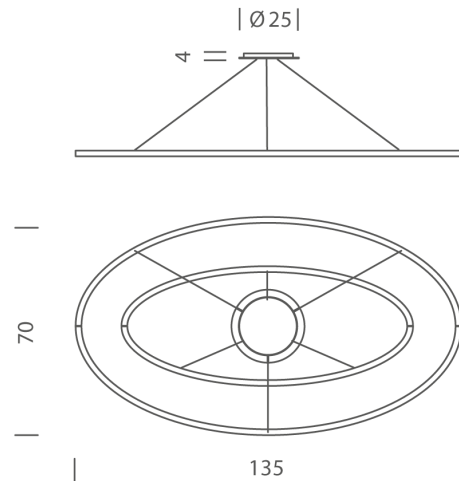

Materials	Aluminium	Source	90W LED	Colour Temp	3000K
Output	2825+1850lm	CRI	85	Emission	diffused orientable uplight(minor), diffused orientable downlight (major)
IP Rating	IP20	Dimming	1-10v		