

AX S/ALYSOID/34/BN

Alysoid Pendant

by Ryosuke Fukusada

ALYSOID, the first project by Japanese designer Ryosuke Fukusada for Axo Light, is inspired by the world of geometry and architecture. A collection of aluminum handcrafted suspension lamps characterized by elegant, draped chains which define the diffuser. Available in various sizes with nickel or brass chains. Winner of a 2017 GOOD DESIGN AWARD by the Chicago Athenaeum MUSum of Architecture and Design.



Designer	Ryosuke Fukusada
Supplier	Axo Light
Country	Italy
SKU	AX S/ALYSOID/34/BN
Finish	Nickel Chains
Size	34

Product Dimensions

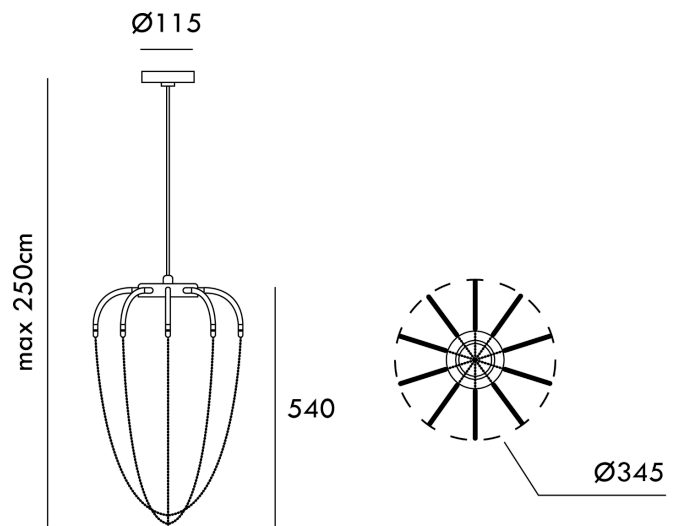

Weight	2.5kg
Colour Temp	3000K
Emission	Diffused beam

Materials	Aluminium
Output	1230lm
IP Rating	IP20

Source	20W LED
CRI	90
Dimming	PHASE